

Controllable diaphragm pump

Flow capacity 11 l/h ... 220 l/h

Admiss. counterpressure up to 20 bar



C409.2-...ML



C409.2-...ML in survey

- Multi-layer diaphragm technology
- Safe to run dry
- Leakage free
- Low maintenance
- Easy to use
- High dosing accuracy
- Multifunctional
- PROFIBUS DP - interface
- Flexible
- Manual stroke length and stroke frequency adjustment
- Robust metallic housing

Infobox

- Order information [Page 2.49](#)
- Options/accessories [Page 2.49](#)
- fittings-allocation [Page 2.52](#)
- connecting pieces [Chapter 4](#)
- resistance chart [Chapter 5](#)
- installation examples [Chapter 5](#)

Functions and operating modes

- Manual operation
- Manual stroke frequency adjustment
- PROFIBUS DP-VO slave Interface
- External START/STOP
- Pulse operation / fractinator
- Cycle delay unit
- Analogue operation (0/4-20 mA)*
- Analogue operation standardization
- Charge manual/with timer*
- Speed control / Slow mode
- 3 LED's for status indication
- Multiline illuminated text display
- Menu - driven parameterization
- Flow indication
- Calibration
- 4 - key operation
- 2 digital outputs (PLC)*
- 1 digital input (PLC or contact signal)*
- 2 analogue / digital inputs (optionally reversible)*
- Programmable input- / output functions*
- Connection / evaluation 2-stage level monitoring
- Connection / evaluation diaphragm rupture monitoring
- Connection / evaluation flow monitoring
- Connection / evaluation flow metering
- Voltage 210 - 250 V, 50/60 Hz
- 2m connecting cable Euro-plug

Technical data

Type	Nominal capacity	Nominal stroke frequency	Capacity per stroke	Admiss. counter-pressure	Admiss. pressure at pump inlet	Max. suction height	Inlet / Outlet width	Max. stroke length	Motor output
	l/h	1/min							
C409.2-11ML	0 - 11	100	1,8	20	-0,3 / 0	3	10	4	0,37
C409.2-17ML	0 - 17	150	1,8	20	-0,3 / 0	3	10	4	0,37
C409.2-30ML	0 - 30	100	5	16	-0,3 / 0	3	10	6	0,37
C409.2-45ML	0 - 45	150	5	16	-0,3 / 0	3	10	6	0,37
C409.2-72ML	0 - 72	100	12	10	-0,3 / 0	3	15	8	0,37
C409.2-110ML	0 - 110	150	12,2	8	-0,3 / 0	3	15	8	0,37
C409.2-150ML	0 - 150	100	25	4	-0,3 / 0	3	15	10	0,37
C409.2-220ML	0 - 220	150	24	3	-0,3 / 0	3	15	10	0,37

Dimensional drawing

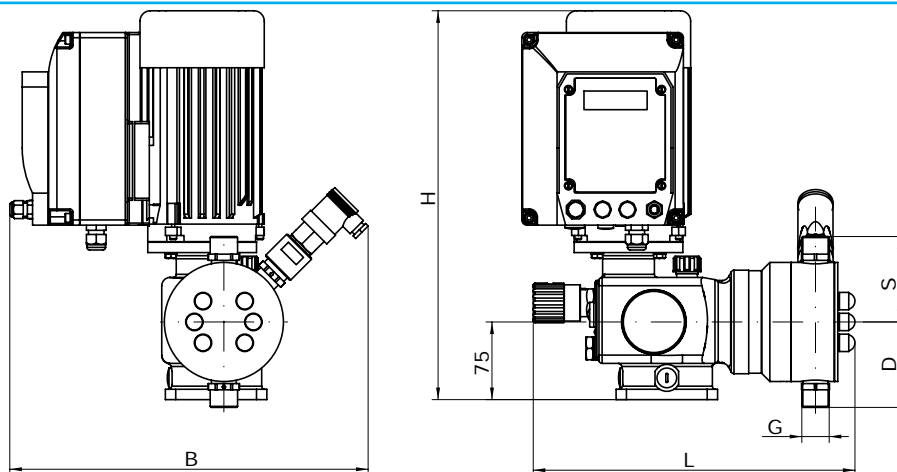

Dimensional chart

All indications in mm

Type	G	S	D	L	B	H	Weight (kg)
C409.2-11ML	G 3/4	83	83	321	346	376	15,5
C409.2-17ML	G 3/4	83	83	321	346	376	15,5
C409.2-30ML	G 3/4	90	90	319	351	376	16,0
C409.2-45ML	G 3/4	90	90	319	351	376	16,0
C409.2-72ML	G 3/4	94	94	324	353	376	16,5
C409.2-110ML	G 3/4	94	94	324	353	376	16,5
C409.2-150ML	G1 1/4	127	127	341	368	376	17,5
C409.2-220ML	G1 1/4	127	127	341	368	376	17,5

- * inapplicable when supplied with PROFIBUS DP - Interface
- Indication of weight for basic design acc. to order information

Order information

Basic design

C409.2-11ML up to C409.2-45ML

- Pump body PP-FRP
- Double valves PP-FRP
- Valve balls glass
- Valve seals FPM
- Multi-layer diaphragm PTFE
- Pressure switch IP65
- Control cable (8-pole)

C409.2-72ML up to C409.2-220ML

- Pump body PP-FRP
 - Single valves PP-FRP
 - Valve balls glass
 - Valve seals FPM
 - Multi-layer diaphragm PTFE
 - Pressure switch IP65
 - Control cable (8-pole)
- Motor:**
- 210-250V 50/60 Hz, 1~, IP 55, ISO F
- Further options and accessories:**
- Connection pieces see chapter 4
 - Product documentation see chapter 5

Type	Basic design	x
C409.2-11ML	16013301	
C409.2-17ML	16013302	
C409.2-30ML	16013303	
C409.2-45ML	16013304	
C409.2-72ML	16013305	
C409.2-110ML	16013306	
C409.2-150ML	16013307	
C409.2-220ML	16013308	

Options/Accessories			C409.2-11ML C409.2-17ML	x	C409.2-30ML C409.2-45ML	x	C409.2-72ML C409.2-110ML	x	C409.2-150ML C409.2-220ML	x
Pump body and valves 	PP	Single valve PP-FRP	-		-		●		●	
		Double valve PP-FRP	●		●		-		-	
	PVC-U	Single valve PVC-U	-		▲		▲		▲	
		Chamber valve (double valve) PVC-U	▲		-		-		-	
	PVDF	Single valve PVDF-FRP	-		-		▲		▲	
		Double valve PVDF-FRP	⊙		▲		-		-	
	1.4571	Single valve 1.4571/1.4581	-		-		-		▲	
Double valve 1.4571/1.4581		▲		▲		▲		⊙		
Valve balls 	Glass	Single valve	-		○		●		●	
		Double valve	●		●		-		-	
	1.4401	Single valve PVC-U	-		○		○		▲	
		Single valve	-		○		○		▲	
	PTFE	Double valve	○		○		○		-	
		Single valve	-		▲		▲		▲	
Double valve	▲		▲		▲		-			
Valve seals 	FPM	Single valve	-		○		●		●	
		Double valve	●		●		-		-	
	EPDM	Single valve	-		○		○		○	
		Double valve	○		○		○		-	
	FEP-covered	Single valve	-		▲		▲		▲	
		Double valve	▲		▲		▲		-	
Stroke length adjustment 	with position indicator		▲		▲		▲		▲	
	Stroke length adjustment electrical 	Actuator N C1-BA 230 V, +/- 10%, 50/60 Hz, 128s/10 U, 1,5 Nm incl. mounting kit for actuator		▲		▲		▲		▲
Electronic positioning controller PMR3 input signal 0/4-20 mA incl. feedback signal 0/4-20 mA (only in N C1-BA integrated)		▲		▲		▲		▲		

● = basic design ▲ = with add. price ○ = without add. price ⊙ = on request - = not available Art.-No. = available in basic design/accessories

C409.2-...ML

Order information

Basic design

C409.2-11ML up to C409.2-45ML

- Pump body PP-FRP
- Double valves PP-FRP
- Valve balls glass
- Valve seals FPM
- Multi-layer diaphragm PTFE
- Pressure switch IP65
- Control cable (8-pole)

C409.2-72ML up to C409.2-220ML

- Pump body PP-FRP
- Single valves PP-FRP
- Valve balls glass
- Valve seals FPM
- Multi-layer diaphragm PTFE
- Pressure switch IP65
- Control cable (8-pole)

Motor:





- 210-250V 50/60 Hz, 1~, IP 55, ISO F

Further options and accessories:

- Connection pieces see chapter 4
- Product documentation see chapter 5

Type	Basic design	x
C409.2-11ML	16013301	
C409.2-17ML	16013302	
C409.2-30ML	16013303	
C409.2-45ML	16013304	
C409.2-72ML	16013305	
C409.2-110ML	16013306	
C409.2-150ML	16013307	
C409.2-220ML	16013308	

2

Options/Accessories		C409.2-11ML C409.2-17ML	x	C409.2-30ML C409.2-45ML	x	C409.2-72ML C409.2-110ML	x	C409.2-150ML C409.2-220ML	x
Drive motor  <p>Voltage 115V / 50/60 Hz</p>		○		○		○		○	
Profibus  <p>Profibus-interface: Profibus DP-V0 (slave) Bit rate: Automatic 9,6 kbit/s – 12 Mbit/s Connection to dosing pump: M12-cable box, 5-pole, B-coded</p>		▲		▲		▲		▲	
Profibus Y-distributor M12x1, 5-pole, IP67		90025526		90025526		90025526		90025526	
Profibus T-distributor M12x1, 5-pole, IP67		90022889		90022889		90022889		90022889	
Profibus terminating resistor M12x1, 5-pole, IP67		90022890		90022890		90022890		90022890	
Control electronics  <p>Remote-design, for wall mounting incl. 3m cable and fixing materials</p>		○		○		○		○	
Control cable  <p>M12 cable box 3-pole, 5 meter for level input (Level sensor not included)</p>		90022888		90022888		90022888		90022888	
M12 cable box 3-pole, ready-made for level input (Level sensor not included)		90022877		90022877		90022877		90022877	
Special connection  <p>Special connection (plug) for power supply</p>		○		○		○		○	

● = basic design ▲ = with add. price ○ = without add. price ⊗ = on request -- = not available Art.-No. = available in basic design/accessories

Order information

Basic design



C409.2-11ML up to C409.2-45ML

- Pump body PP-FRP
- Double valves PP-FRP
- Valve balls glass
- Valve seals FPM
- Multi-layer diaphragm PTFE
- Pressure switch IP65
- Control cable (8-pole)

C409.2-72ML up to C409.2-220ML

- Pump body PP-FRP
 - Single valves PP-FRP
 - Valve balls glass
 - Valve seals FPM
 - Multi-layer diaphragm PTFE
 - Pressure switch IP65
 - Control cable (8-pole)
- Motor:**
- 210-250V 50/60 Hz, 1~, IP 55, ISO F
- Further options and accessories:**
- Connection pieces see chapter 4
 - Product documentation see chapter 5

Type	Basic design	x
C409.2-11ML	16013301	
C409.2-17ML	16013302	
C409.2-30ML	16013303	
C409.2-45ML	16013304	
C409.2-72ML	16013305	
C409.2-110ML	16013306	
C409.2-150ML	16013307	
C409.2-220ML	16013308	

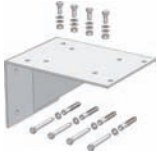
Options/Accessories		C409.2-11ML C409.2-17ML	x	C409.2-30ML C409.2-45ML	x	C409.2-72ML C409.2-110ML	x	C409.2-150ML C409.2-220ML	x
Flow controller*  *Angaben im Datenblatt beachten	IP65 incl. cable 0,6m and cable box M12 - 5-pole (bushing for pump connection) Material valve seals: FPM Connectio thread: 8191.1/8192.1: Inlet: G 3/4 (inside), Outlet: G 3/4 (outside) Gewindeanschluss 8191.1/8192.1: Inlet: G 1 1/4 (inside), Outlet: G 1 1/4 (outside) Max. operating pressure: 10 bar								
	8191.1	PVC-U/FPM	37602227	–	–	–	–		
		PP/FPM	37602175	–	–	–	–		
	8192.1	PVC-U/FPM	–	37602176	37602176	–	–		
		PP/FPM	–	37602177	37602177	–	–		
8193.1	PVC-U/FPM	–	–	–	–	⊙			
	PP/FPM	–	–	–	–	⊙			
Flow meter*  *Note the indications at the data sheet	IP65 incl. cable 0,6m and cable box M12 5-pole (bushing for pump connection) Connection thread: 8012.1 - 8014.1: Inlet: G 3/4 (inside), Outlet: G 3/4 (outside) Connection thread: 8015.1: Inlet: G 1 1/4 (inside), Outlet: G 1 1/4 (outside) Max. operating pressure: 10 bar								
	8012.1	PVC-U/FPM	37602277	–	–	–	–		
		PVDF/FPM	37602307	–	–	–	–		
	8013.1	PVC-U/FPM	–	37602279	–	–	–		
		PVDF/FPM	–	37602309	–	–	–		
	8014.1	PVC-U/FPM	–	–	37602281	–	–		
		PVDF/FPM	–	–	37602311	–	–		
8015.1	PVC-U/FPM	–	–	–	–	37602320			
	PVDF/FPM	–	–	–	–	37602332			
Console 	for wall mounting incl. fixing screws								
	1.4301		90023875	90023875	90023875	90023875			
	PP		90023848	90023848	90023848	90023848			

● = basic design ▲ = with add. price ○ = without add .price ⊙ = on request – = not available Art.-No. = available in basic design/accessories

Fittings for suction side of dosing pumps		C409.2-11ML C409.2-17ML		C409.2-30ML C409.2-45ML		C409.2-72ML		C409.2-110ML		C409.2-135ML		C409.2-220ML	
		Typ	S.	Typ	S.	Typ	S.	Typ	S.	Typ	S.	Typ	S.
Pulsation damper without separating diaphragm	PVC-U / PP	702.1	3.14	702.1	3.14	702.1	3.14	702.1	3.14	702.1	3.14	702.1	3.14
	1.4571	⊗		⊗		⊗		⊗		⊗		⊗	
	with level switch 1-stage	SL-11.1	3.34	SL-02	3.36	SL-02	3.36	SL-02	3.36	SL-02	3.36	S-04	3.40
		–		S-03	3.38	S-03	3.38	S-03	3.38	S-03	3.38	–	
	Suction lance	without level switch	S-01	3.46	S-01	3.46	S-01	3.46	S-01	3.46	S-01	3.46	S-01
SH-04.1		3.44	–		–		–		–		–		
with level switch 2-stage	SL-12.1	3.34	–		–		–		–		–		
Priming aid	PVC-U-transparent	770.2	3.76	770.2	3.76	770.2	3.76	770.2	3.76	770.2	3.76	770.2	3.76
Calibration Pot	PVC-U	792.1	3.78	792.1	3.78	793.1	3.78	793.1	3.78	793.1	3.78	794.1	3.78
Foot valve	PVC-U	731	3.82	731	3.82	731	3.82	732.2	3.80	732.2	3.80	732.2	3.80
	PP / PVDF	–		–		–		732	3.82	732	3.82	732	3.82
	1.4571	731	3.82	731	3.82	731	3.82	732	3.82	732	3.82	732	3.82
	PP-FRP / PVDF-FRP	781.1	3.86	781.1	3.86	781.1	3.86	–		–		783.1	3.86
Line strainer	PVC-U	751.1	3.88	751.1	3.88	751.1	3.88	751.1	3.88	751.1	3.88	–	
	PVC-U / PP / PVDF	752.1	3.88	752.1	3.88	752.1	3.88	752.1	3.88	752.1	3.88	752.1	3.88
	1.4408	752	3.90	752	3.90	752	3.90	752	3.90	752	3.90	752	3.90
Float valve	PVC-U	871	3.92	871	3.92	871	3.92	871	3.92	871	3.92	872	3.92

Fittings for pressure side of dosing pumps		C409.2-11ML C409.2-17ML		C409.2-30ML C409.2-45ML		C409.2-72ML		C409.2-110ML		C409.2-135ML		C409.2-220ML	
		Typ	S.	Typ	S.	Typ	S.	Typ	S.	Typ	S.	Typ	S.
Diaphragm-type relief valve		620.10	3.4	620.10	3.4	620.10	3.4	622.10	3.4	622.10	3.4	622.10	3.4
Diaphragm-type pressure keeping valve		620.D	3.8	620.D	3.8	620.D	3.8	622.D	3.8	622.D	3.8	622.D	3.8
Multi-function valve	4 bar opening pressure	MFV 05004	3.10	MFV 05004	3.10	–		–		–		–	
	6 bar opening pressure	MFV 05006	3.10	MFV 05006	3.10	–		–		–		–	
	10 bar opening pressure	MFV 05010	3.10	MFV 05010	3.10	–		–		–		–	
Pulsation damper without separating diaphragm	1.4571	⊗		⊗		⊗		⊗		⊗		⊗	
Diaphragm-pulsation damper with PTFE/PTFE-faced diaphragm	PVC-U / PP / PVDF	720.1	3.22	721.2	3.22	721.2	3.22	722.1	3.22	722.1	3.22	722.1	3.22
Diaphragm-pulsation damper with Elastomer-diaphragm	1.4571	721.1	3.26	721.1	3.26	721.1	3.26	722.1	3.26	722.1	3.26	722.1	3.26
	1.4571	810.1-0,16/180	3.28	810.1-0,16/180	3.28	810.1-0,16/180	3.28	810.1-0,32/160	3.28	810.1-0,32/160	3.28	810.1-0,75/140	3.28
Check valve	PP-FRP / PVDF-FRP	661.2	3.50	661.2	3.50	661.2	3.50	661.2	3.50	663.2	3.50	663.2	3.50
	PVC-U	661.2	3.50	661.2	3.50	661.2	3.50	661.2	3.50	–		–	
	1.4571	661.2	3.50	661.2	3.50	661.2	3.50	661.2	3.50	662.2	3.50	662.2	3.50
Dosing valve	PP-FRP / PVDF-FRP	691.1	3.54	691.1	3.54	691.1	3.54	691.1	3.54	693.1	3.54	693.1	3.54
	1.4571	691.1	3.54	691.1	3.54	691.1	3.54	691.1	3.54	692.1	3.54	692.1	3.54
	PVC-U	691.1	3.54	691.1	3.54	691.1	3.54	691.1	3.54	–		–	
	PVC-U / PP / PVDF	681.1	3.58	681.1	3.58	681.1	3.58	681.1	3.58	682.1	3.58	682.1	3.58
Injection fitting	PVC-U / PP / PVDF	8061.1	3.60	8061.1	3.60	8061.1	3.60	8061.1	3.60	8062.1	3.60	8062.1	3.60

⊗ = on request – = not available

The above allocation considers the fittings which have to be used at least regarding their nominal width in order to ensure the safe and trouble-free operation of the respective pumps when feeding liquids which are similar to water. Absolutely note the max. admissible operating pressure of the fittings.

The use of fittings of a bigger nominal width is unproblematically possible in most cases.

When choosing the fittings note the installation instructions for dosing pumps or confer with **sera**.

Inquiry Order **No.:** **Date:**

Customer data

Company:	Name: Phone: Fax: E-mail:
Project/Commission:	

Medium

Medium with Attributes: (Concentration, temperature, viscosity...)

Inquiry-/Orderinformation

Article (Basic design) Type	Options / Accessories		Article-No.	Piece/s
	Description	Specification		
R 409.2-18e	Valve balls	PTFE	16005264	1
	integrated relief valve	PP		1
	Hoze nozzle compl.	PP, d12	90003877	2
620.10			37600014	1

Remarks

.....

.....

.....
Place and date

.....
Stamp and signature



Customer data

Company:.....	Name: Phone: Fax: E-mail:
--	--

Medium

Medium ¹⁾	
Concentration (%)	Vapour pressure at operating temperature (bar)
Viscosity (mPas)	Solids content - size
Operating temperature max. (°C)	Operating temperature min. (°C)
Dosing accuracy (%)	Density (g/cm ³)

Operating data

Nominal capacity max. (l/h) ¹⁾	Nominal capacity min. (l/h)
Pressure at the pump pressure joint (bar) ¹⁾	Pressure at suction joint (bar) ¹⁾
Pressure line width (DN)	Total length of pressure line (m)
Suction line width (DN)	Total length of suction line (m)
Max. suction height (m WS)	Type of stroke adjustment
Material at pressure line	Material suction line

Motor data

Voltage (V)	Voltage type
Frequency (Hz)	Protection class (IP)

¹⁾ This is the minimum information required for an offer!

Remarks









.....

.....
Place and date

.....
Stamp and signature

5

Please use the following symbols

- | | | | |
|---|-------------------------|---|---------------------------------|
|  | 1 Suction tank |  | 5 Relief valve |
|  | 2 Shut-off valve |  | 6 Pressure-keeping valve |
|  | 3 Line strainer |  | 7 Pulsation damper |
|  | 4 Dosing pump |  | 8 Manometer |
| | |  | 9 Ball check valve |

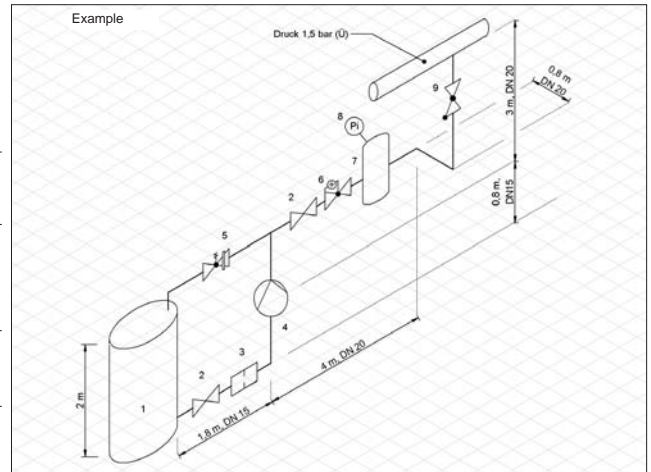

R+I-diagram (sketch)



In general

sera - products from the current **sera** - catalogues are supplied with a product documentation that contains the following standard:

1. User's information:
 - Operating instructions (series)
 - Dimensional drawings (only for information)
 - Component list (list of parts)
2. Quality documentation:
 - Inspection certificate covering pump test (for pumps without extra charge)
 - Declaration of conformity (without extra charge)
 - Declaration of manufacturer (without extra charge)
 - Testing certificate / Certificates (acc. to the specification for extra charge)

Language and quantity

The documentation is made in German and English language one-folded without extra charge.

Documentation in another language and multiple copies can be delivered on request for extra charge.

Customized designs

Documentations for **sera** - products which are designed as variation or product combinations from this product-catalogue are delivered as composed documentation.

Used products and components are documented as above mentioned.

Construction data

Drawings true to scale for **sera** - products as data sheet or drawing can be made on request for extra charge.

External products

If available, product documentation of external products will be added in original, one-folded and according to our specification for documentation.

Documentation-Specification

Product documentation according to the customer's specification can be made on request and for extra charge.

Electronic design

sera - product documentation can be changed to electronic data (pdf-file) on request for extra charge and can be sent on data medium or per e-mail.

sera - construction data can be changed to electronic data (dxf-file) on request for extra charge and can be sent on data medium or per e-mail.

Download

There is appropriate information (technical data sheet) about our range of products on the **sera** - homepage www.sera-web.de for download!

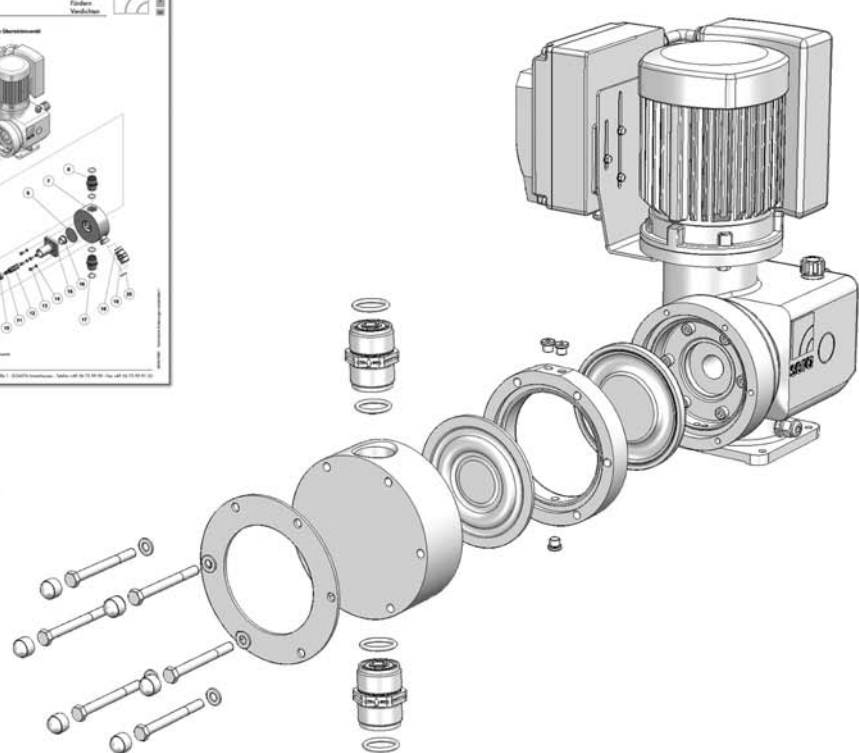
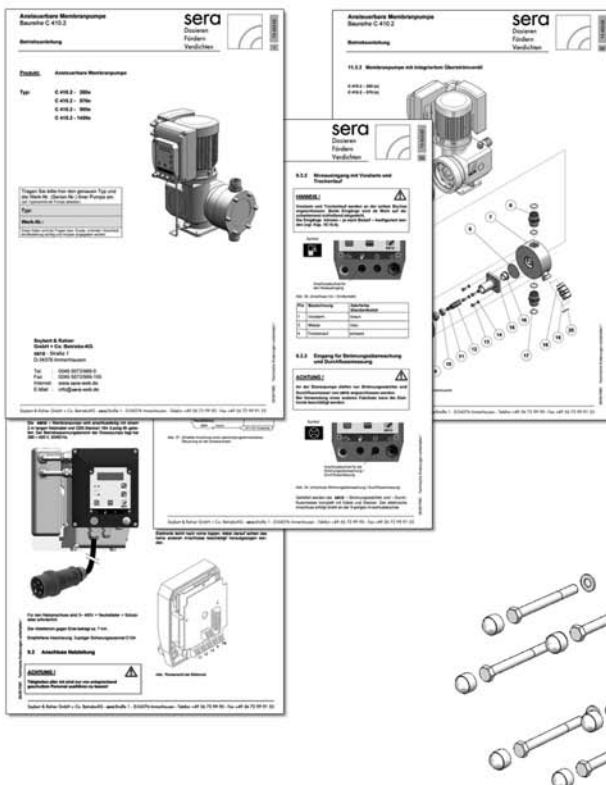

1. Standard Terms and Conditions

As a matter of principle, deliveries and services (hereinafter referred to as 'deliveries') shall ensue on the basis of the mutual agreements, the relevant written order confirmation and the following conditions. Any other conditions of the ordering party shall be valid only if we have given consent in writing. This shall apply likewise for the amendment of existing agreements. Our quotation is without engagement.

Documents enclosed to a quotation and/or an order confirmation, for example descriptions, diagrams, drawings, specifications relating to performance, weights and measurements, are only approximations unless they are expressly referred to as binding. We retain the right of ownership and the copyright to these documents.

Parts for installation, processing or repair must be sent, carriage paid up to our works, enclosing a packing slip. A despatch note must be sent to us stating the order number.

2. Prices and terms of payment

The prices quoted by us are for delivery ex Immenhausen works excluding packing unless anything different has been agreed in writing, and they do not include the legally applicable VAT. Dispatch shall be at the cost of the recipient or ordering party. Packing costs shall be charged separately. Packing material shall not be taken back.

Partial deliveries shall be permissible where they are agreed with the ordering party or where the latter can reasonably be expected to accept them.

Payments are to be made within 30 days from the date of invoice, net without deduction and without any offsetting or retention. Where no due invoices are outstanding, we grant 2 % cash discount for payment within 14 days of invoice date. In particular cases we may demand payment in advance or cash on delivery. Invoices for mounting on site are to be paid net without discount immediately after receipt.

With payments of all types the payment date is the day on which the amount is available to us.

In the case of late payment we shall have the right to charge the purchaser penalty interest pursuant to § 288 BGB (German Civil Code).

3. Period of delivery

The period of delivery shall commence after the final technical and commercial clarification of detail and after submission of all documents, authorisations and clearances to be obtained by the ordering party and fulfilment of other contractual obligations such as any agreed advance payments.

The delivery period is deemed to have been observed if, by the time the delivery period expires, the goods to be delivered have left our works or advice of their readiness for dispatch has been sent.

If technical or commercial conditions of contract are altered at the instigation of the purchaser after our statement of the period of delivery, the period of delivery shall start again from the beginning (without the need for any notification), and all other contractual agreements depending on this are to be newly agreed.

The period of delivery shall be increased further to a reasonable extent if any unforeseen hindrances occur that are beyond our control, irrespective of whether they have occurred on our side or with our suppliers.

The institution of bankruptcy or composition proceedings, the making of a statutory declaration in accordance with § 807 of the Ger

man Code of Civil Procedure, any payment difficulties occurring, or our awareness of an appreciable deterioration in the financial standing of the purchaser entitle us to discontinue all deliveries immediately and to refuse to execute current contracts.

In a case where the agreed period of delivery is exceeded, a delay shall commence only at the time of a corresponding written notification from the purchaser to us. After expiry of a reasonable additional period the purchaser may withdraw from the contract only if we are responsible for the delay.

4. Transfer of risk

As soon as the goods leave the works, the risk of delivery passes to the buyer. This shall apply even if carriagepaid delivery or free delivery has been agreed by way of exception.

Goods ready for dispatch must be called for immediately, otherwise we will store them at the risk and expense of the buyer. In the event of such a storage, we are only obliged to take the same care and attention with the goods as we customarily take in our own affairs.

5. Reservation of title

Our deliveries are made solely subject to reservation of title. The delivered goods remain our property, as goods subject to reservation of title, until payment of the purchase price and settlement of all claims arising in connection with the business transaction and claims which may arise in connection with the purchased goods. The enforcement of reservation of title, in particular through the repossession of the goods, which is admissible in the event of payment default or jeopardy to our claim to title, is not deemed to be a rescission of the contract.

As long as the ownership of the goods has not been transferred to the purchaser or his customer, we have the right of coownership of the new articles if they combine or process the goods which are subject to reservation of title with other goods not belonging to us, namely in the ratio of the value of the goods subject to reservation of title to the other connected or processed goods at the time of the connection or processing.

The purchaser may only sell the goods subject to reservation of title in the ordinary course of business and on normal business terms and as long as the purchaser is not in default. He is not entitled to dispose of the goods in other ways, in particular to pledge them or transfer ownership as security.

The purchaser must notify us without delay of any acts of third parties aimed at the goods delivered under reservation of title or at the assigned accounts receivable. With the discontinuation of payment, filing or opening of bankruptcy proceedings, judicial or out-of-court composition proceedings by the purchaser, his rights to resale, use or installation of the goods subject to reservation of title are extinguished. In these cases we are entitled to demand the immediate surrender of the goods subject to reservation of title to the exclusion of any rights of retention.

The purchaser hereby declares his agreement that any persons engaged by us for collection of goods may enter and use the site on which the goods to be collected are located.

Notwithstanding the purchaser's obligation to pay, we are entitled to sell repossessed goods in whatever way we choose or have

them auctioned. The proceeds, up to a maximum of the purchase price, will be credited after deduction of any decrease in value and repossession costs. The purchaser will assign to us in advance as security the accounts receivable due to him from the resale of the goods subject to reservation of title or due to him on any other legal grounds; regardless of whether the goods were sold unprocessed, processed or together with other services to one or more buyers.

The same is applicable to the incorporation of goods into property or plants which are coupled with buildings or if the goods are used to fulfil contracts for work or contracts for work and delivery.

At our request the purchaser is obliged to notify the subpurchasers that he has assigned his claims and to surrender documents and give us the information required to assert our rights against the subpurchasers. We are entitled to collect the accounts receivable ourselves.

The purchaser is empowered to collect the accounts receivable he has assigned as long as he meets his contractual payment obligations towards us. The purchaser must pass on to us the amounts which he has collected for us when our accounts are due. If the value of the securities given to us exceeds our claims arising from delivery by a total of more than 20 %, we are obliged, at the request of the purchaser, to retransfer the rights to him to this extent.

6. Material defects and liability

The existence of defects due to a circumstance existing prior to the transfer of risk must be notified to us by the purchaser immediately in the form of a written complaint. In the case of genuine defects the purchaser shall in the first place only have a claim to subsequent fulfilment, which we may provide by rectification of the defect or delivery of a defectfree item at our discretion. Place of fulfilment is exclusively the head office of the buyer. The purchaser must grant us the necessary time and opportunity free of charge to undertake subsequent performance.

In the case of damage incurred due to the following reasons the purchaser shall have no entitlement to rectification of the defect: incorrect or incomplete performance specifications or instruction by the purchaser; materials or components that have been supplied or specified by the purchaser; unsuitable or incorrect use, incorrect assembly or activation by the purchaser or third party despite availability of correct instruction; unsuitable operating conditions, excessive stress, natural wear and tear, incorrect or negligent treatment; unsuitable operating resources, substitute materials; defective construction works, unsuitable land plot; detrimental chemical, electrochemical or electrical influences, detrimental effects of weather.

With singleshift operation (up to 8 hours daily) the guarantee period is twelve months from date of commissioning but maximum fourteen months from date of dispatch from our Immenhausen works. With multiple shift operation the guarantee period is reduced accordingly. The guarantee period for the original delivery is applicable for any repair work performed by us or replacement parts we supplied. If the purchaser or a third party performs repair work or any other interventions during the guarantee period without our prior consent, our guarantee becomes void. If a justified complaint is made in the Federal Republic of Germany, our guarantee covers repair of the defective parts in our works or the delivery of replacement parts.

Outside the Federal Republic of Germany, our guarantee is limited to delivery of replacement parts. Replaced parts become our property. With repairs our guarantee is restricted to the replaced individual parts. The purchaser's claim for compensation for loss or damage or reimbursement of expenses due to a breach of obligation or other legal grounds shall be excluded. This restriction shall not apply where liability is compulsory because of intent, gross negligence or the violation of life, body or health.

7. Place of performance and venue, applicable law

The venue for all disputes arising from the contract is the Local Court of Hofgeismar if the subject matter does not fall within the jurisdiction of the Regional Court of Kassel.

The law of the Federal Republik of Germany is exclusively valid UN sales law (CISG) shall not apply.

8. Concluding terms

The contract remains binding even if some terms are legally inoperative. In case one term is completely or partly inoperative the contractors will endeavour immediately to achieve the intended economic success in another legal way.

Seybert & Rahier GmbH + Co. Betriebs-KG
State: 01/2004